

Quality Screw Conveyor Systems and Components

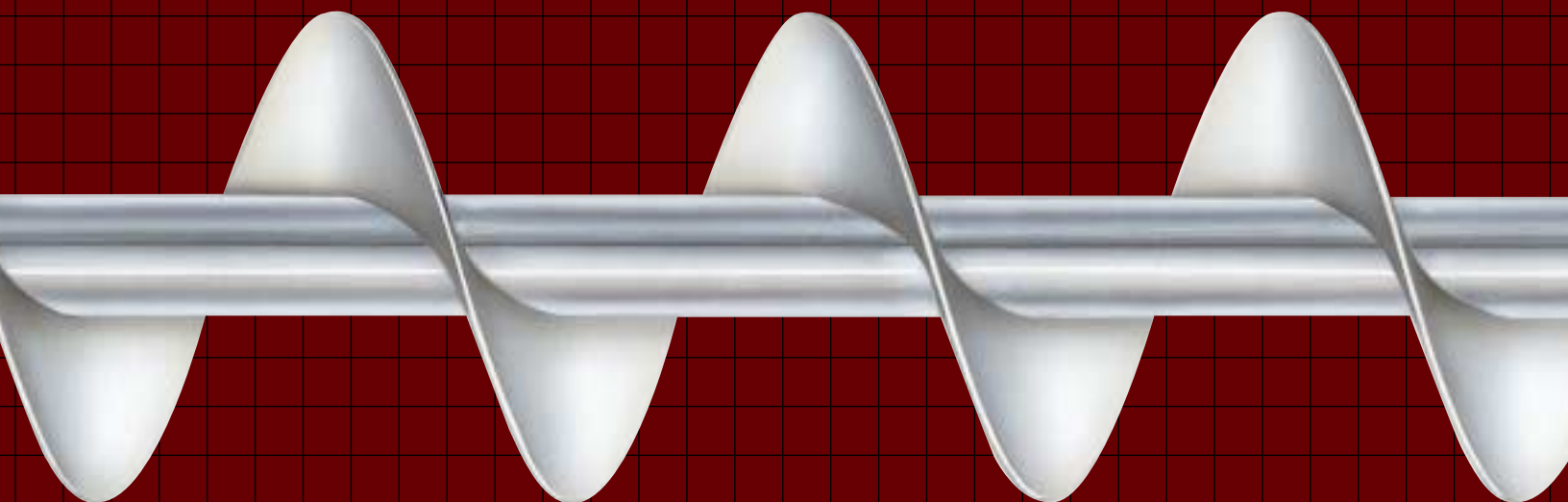

**THE EXPERIENCE
TO HANDLE IT RIGHT!**

Screw Conveyor Corporation®

Quality Screw Conveyor Systems and Components Are

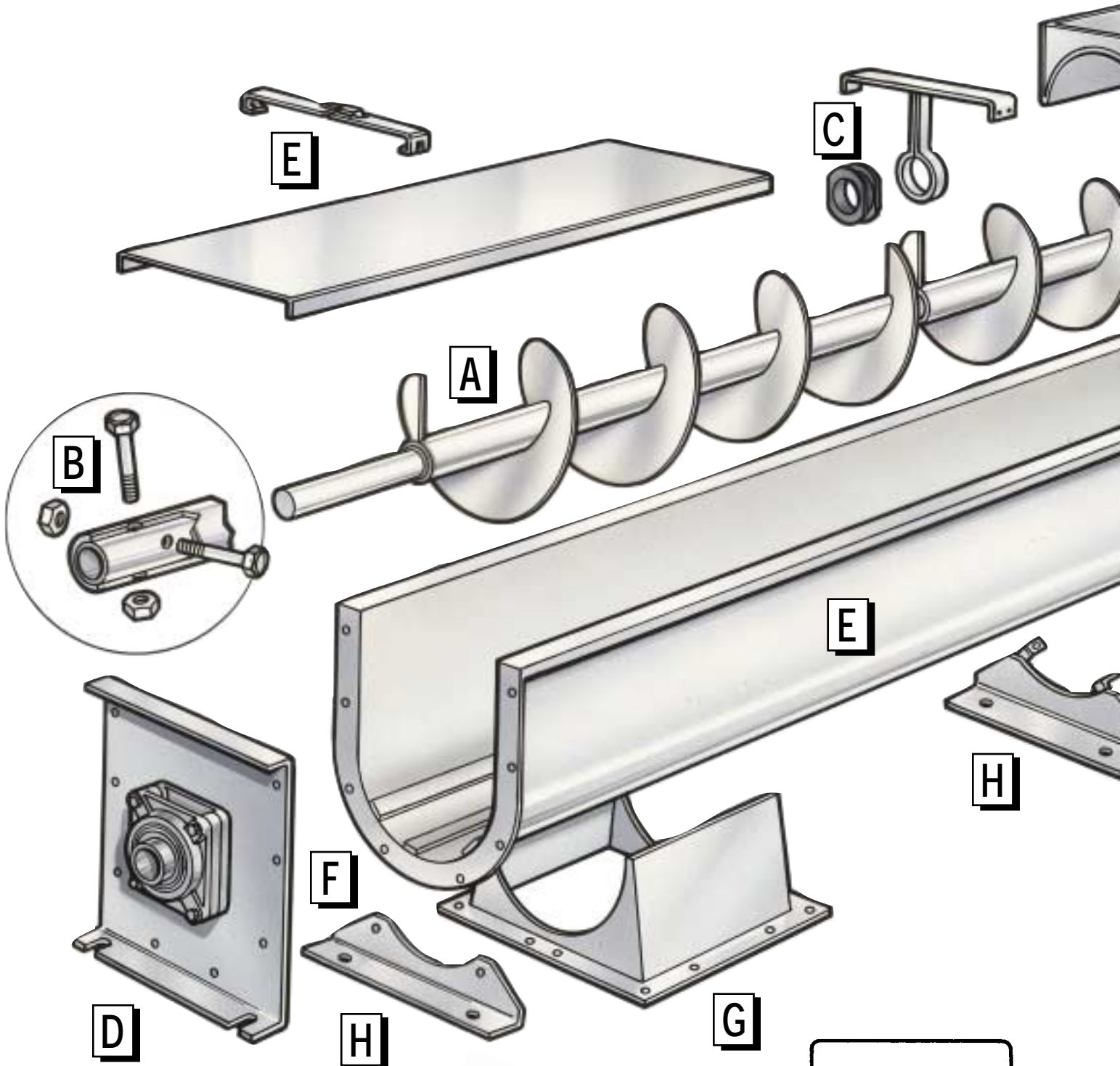

Please refer to Screw Conveyor Corporation Engineering Manual and related current price list for complete details and part numbers.



(Note: Applicable CEMA standards are used throughout the product line.)

Available in a Wide Range of Designs and Materials.

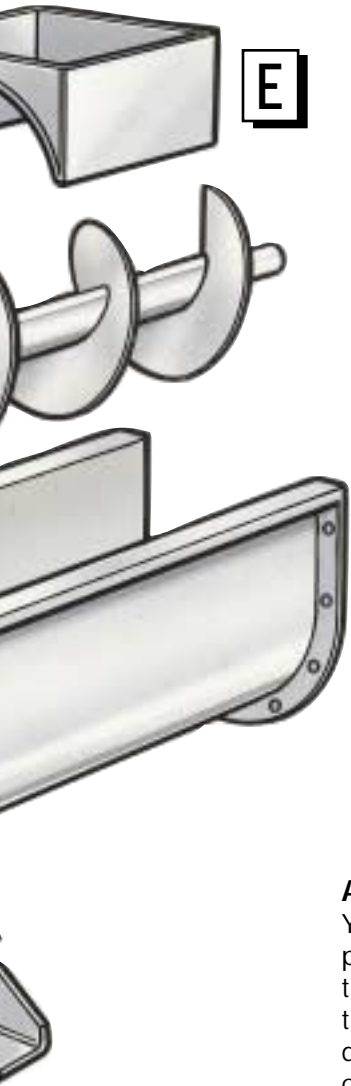

**CARBON STEEL,
STAINLESS STEEL,
AND GALVANIZED STEEL
ARE INVENTORIED
AND READY FOR
IMMEDIATE DELIVERY!**

A WIDE CHOICE OF STANDARD PARTS

You get the system you need to solve your problem — yet keep cost at a minimum. Select the type of component from our standard line that fits your needs. For special flighting designs to solve a particular problem, please consult with one of our four sales offices.

A **Conveyor Screw:** Compact, manufactured straight and accurate in helicoid, sectional, ribbon and special designs to meet your requirements.

B **Job-Rated Components:** Selected to meet the performance required. Precisely worked to insure a longer lasting, truer running unit.

Jig-Drilled Couplings: Assures easy shaft alignment and assembly. Available with "Redi-Change" clamping key for quick disassembly of conveyor screw.

Tem-U-Lac Self-Locking Coupling Bolts: Guards against system damage and costly down-time caused by coupling bolts or nuts working loose.

C **Hangers and Bearings:** Various styles and bearing materials selected to meet your needs.

D **Trough Ends:** Several bearing and seal styles are available to match your needs.

E **Troughs, Covers, Clamps and Shrouds:** Ruggedly constructed standard "U" and other styles of troughs including tubular. Covers, clamps and shrouds available for all applications.

F **Nu-Weld® Flange:** Continuously welded steel flange holds trough in alignment.

G **Discharge Spouts:** All types available... located where you need them...with hand, electric, hydraulic or pneumatic powered gates.

H **Supporting Feet and Saddles:** Align and fasten the trough to the floor or existing structure.

A WIDE CHOICE OF MATERIALS

Stainless Steel Screw Conveyors are ideal for use in the food, pharmaceutical, chemical and virtually all other industries where sanitation, corrosion or extreme temperatures are a problem. Stainless steel conveyor screw and parts are manufactured to the same specifications as standard mild steel. Any analysis of stainless steel can be used in the construction of your screw conveyor. Stainless accessories such as hangers, troughs, etc. are also available.

Corrosion Resistant Conveyor Screws may be made of special resistant metals such as stainless steel, Monel, Inconel, Cor-Ten, etc. They also may be hot dip galvanized for protection against mild corrosion.

Wear Resistant Conveyor Screws and accessories can be furnished in 40/50 carbon A.R. steels, T-1 nickel steel, Hardox 400 or can be coated with Postalloy, Stellite, Aircor, etc.

Conveyor Screws and Flights–Hangers and Bearings

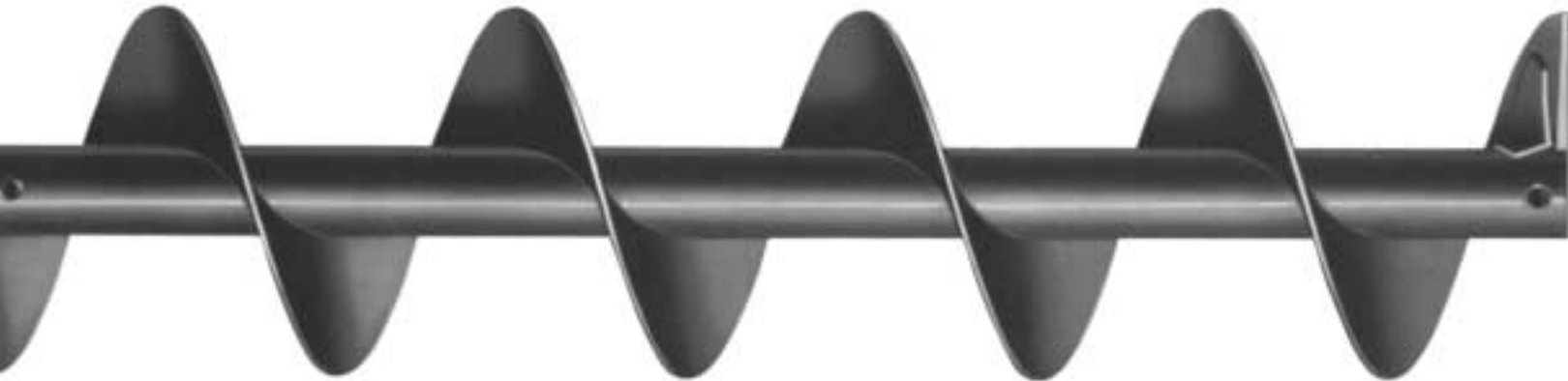

HELICOID CONVEYOR SCREWS UP THRU 20"



FLIGHTS FOR SECTIONAL CONVEYOR SCREWS UP THRU 30"



FLIGHTING FOR HELICOID CONVEYOR SCREWS

We have all the pieces to put together an answer to your bulk material conveying problem. Screw conveyors handle almost any bulk material efficiently and they do it economically compared to other methods. Compact, they fit into tight places, with moving parts enclosed. They're easy to install and simple to maintain. You can run them horizontally, on an incline, and, with our Screw-Lift®, straight up.



RIBBON CONVEYOR SCREWS

We can meet your application needs in helioid and sectional flight types with adaptations including ribbon, special pitches and tapered – in various gauges of steel, stainless steel and other alloys, including hardened flight surfaces.

Whether your need is for components or a complete system, you can rely on our years of experience in the engineering and manufacturing of screw conveyors. Consult our experienced personnel without obligation.



REDI-CHANGE QUICK DISCONNECT CONVEYOR SCREWS

The Redi-Change feature allows you to perform conveyor screw changes and repairs without dismantling the entire conveyor. This feature is available on all types of conveyor screws (not available in 1" shafts).



COUPLINGS



TEM-U-LAC® COUPLING BOLTS



PIPE BUSHINGS

FORMED STEEL LUG FOR DISCHARGE END



FORMED STEEL LUG FOR FEED END



END LUGS

SPECIAL CONVEYOR SCREW DESIGNS

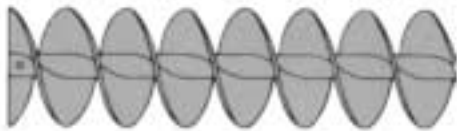

DOUBLE FLIGHT

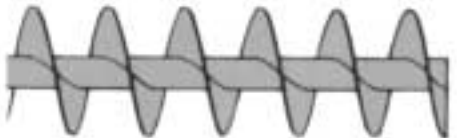

SHORT PITCH

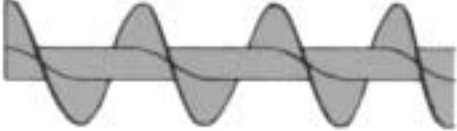

VARIABLE PITCH

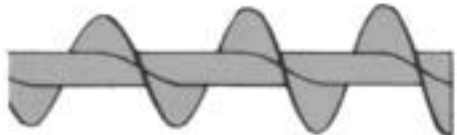

TAPERED DIAMETER



CUT FLIGHTS

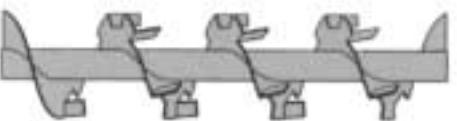

CUT AND FOLDED



MIXING PADDLES (welded or adjustable)



PADDLE CONVEYOR

HANGERS AND REPLACEMENT HANGER BEARINGS



STYLE NO. 220



STYLE NO. 226



STYLE NO. 260



STYLE NO. 230



STYLE NO. 270



STYLE NO. 216



EXPANSION
STYLE NO. 326



FLARED TROUGH HANGER



BEARING FOR
STYLE 220, 226, 326 HANGER



BEARING FOR
STYLE 216, 230 HANGERS



BEARING FOR
STYLE 260, 270 HANGERS

The style 226-Hanger is the most popular since it mounts completely inside the trough and is more suitable for use with dust tight or weather tight covers.

Standard bearings are Babbitt, hard iron, wood, bronze and nylon or Nylatron. Available on special order are Ni-Hard, Bronze Oilite, Gatke, Stellite Bushed, Teflon and many other bearing materials.

Troughs and Trough Ends



Troughs are available in sizes up to 30" and in gauges up to 3/8" thick. They can be formed of stainless steel or other alloys. Nu-Weld® end flanges are continuously jig-welded on each end to assure alignment and tight connecting joints. If supporting feet are needed, they are spaced at the flange joints. Trough saddles are also available.



DOUBLE FLANGED TROUGH



ANGLE TROUGH



SINGLE FLANGED

SPECIAL TROUGH DESIGNS



FLARED TROUGH



CHANNEL TROUGH



JACKETED TROUGH



DROP BOTTOM TROUGH



TUBULAR TROUGH

Troughs may be furnished in a variety of materials including stainless steel, galvanized, monel or other alloys. Covers are usually bolted on or furnished with screw or spring clamps and may be flat for interior or hip roof for exterior installations. Piano hinges are also available.

TROUGH END DESIGNS



STYLE NO. 100



STYLE NO. 101



DISCHARGE TROUGH END
STYLE NO. 104 AND 107



FLARED TROUGH END
STYLE NO. 114 AND 115



BOLT ON SHELF
(Bolts to existing trough ends)

CHEVRON ROLLER BEARING END
THRUST WITH TROUGH END



ANTI-FRICTION STYLE NO. 102
PICTURED WITHOUT SEAL



ANTI-FRICTION STYLE NO. 103
PICTURED WITH PACKING SEAL



NU-WELD® END FLANGE

Nu-Weld® end flanges are made of heavy-gauge steel to assure close accurate fit with the conveyor trough and the trough ends of the following end flange. Bolt holes are jig-punched to assure accurate alignment.



SADDLES AND FEET



TROUGH END DUST SEALS

Trough Covers - Shrouds - Cover Clamps



Note: Standard designs are not intended to be weather, rain, air, or pressure tight. For special design requirements, contact your nearest sales office.

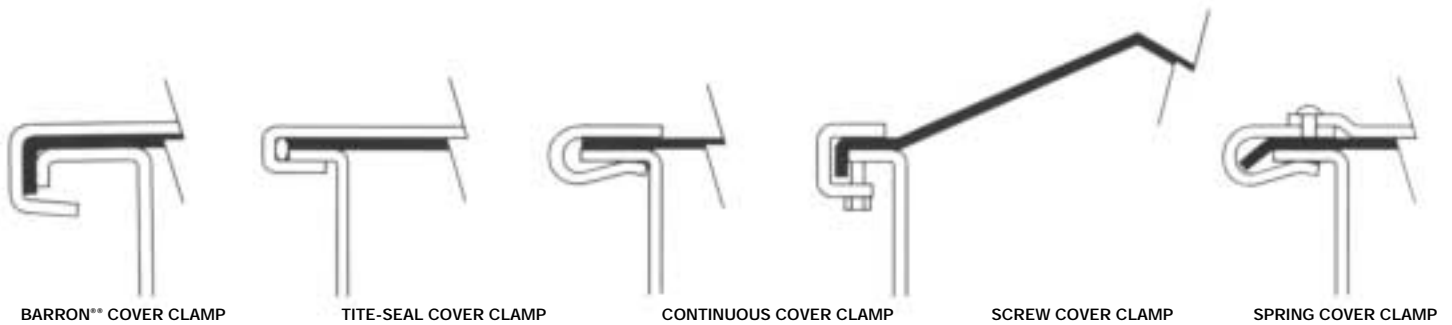

TROUGH COVER CLAMPS

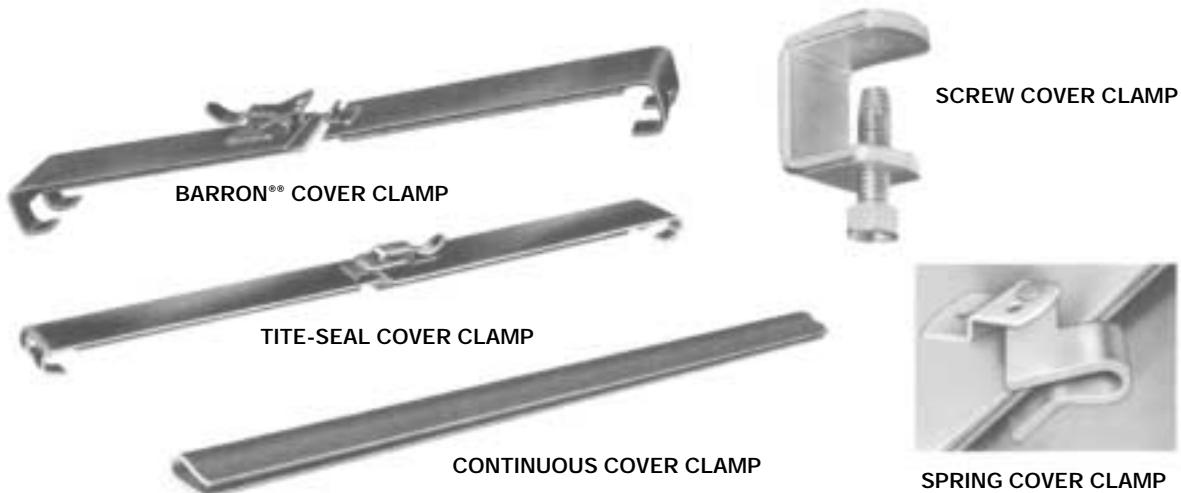

Feed and Discharge Spouts



PLAIN FEED OPENING



DISCHARGE WITH FLAT-HAND SLIDE



PLAIN DISCHARGE



FLUSH END DISCHARGE



FEED SPOUT



DISCHARGE WITHOUT SLIDE

RACK AND PINION GATES

Rack and pinion gates have cut tooth racks welded to the slide plate. This engages a cut tooth pinion mounted on a pinion shaft. Gate may be operated by hand wheel, chain wheel or power operated by electric motors, air or hydraulic cylinders.



FLAT SLIDE



CURVED SLIDE

Screw Conveyor Corporation—Your One Source Supplier

QUALITY COMPONENTS
IN STOCK AND READY
FOR FAST DELIVERY!



Screw Conveyor Corporation has a vast stock of quality components at four major locations across the country. We are committed to supporting the inventory position of our nationwide network of distributors. This commitment assists them in meeting the demands of their customer base with on-time delivery of high quality Screw Conveyor components and replacement parts.

From standard inventory to custom work, we've grown by answering our customer's needs. And we offer it all..concept, engineering, manufacturing and service.

The photos shown on this page represents a cross section of the quality components and replacement parts in stock at four key locations nationwide. For **URGENT DELIVERY** call or fax:



Screw Conveyor Safety Practices



TO AVOID UNSAFE OR HAZARDOUS CONDITIONS, THE FOLLOWING MINIMUM PROVISIONS MUST BE STRICTLY OBSERVED.

- 1.(A) **SCREW CONVEYORS SHALL NEVER BE OPERATED UNLESS THE CONVEYOR HOUSING COMPLETELY ENCLOSES THE CONVEYOR MOVING ELEMENTS.** All necessary housings, covers, safety guards, railings, gratings and power transmission guards must be in place. If the conveyor is to be opened for inspection, cleaning or observation, the motor driving the conveyor is to be locked out electrically in such a manner that it cannot be started by anyone, however remote from the area unless the conveyor housing has been closed and all guards are in place. **THE HOUSINGS, COVERS AND GUARDS ARE NECESSARY TO PREVENT ANYONE FROM ENTERING, REACHING, OR FALLING INTO THE MACHINERY, WHICH MAY RESULT IN SERIOUS PERSONAL INJURY.**
- (B) If the conveyor must have an open housing as a condition of its use, the **entire open conveyor is then to be guarded by a railing, fence or rugged safety grating.**
- (C) Feed openings for shovel, front end loader or other mechanical equipment shall be constructed in such a way that the conveyor is covered by a rugged grating. If the nature of the material is such that a grating can't be used, **then the exposed section of the conveyor is to be guarded by a railing and there shall be warning signs posted.**

2. **DO NOT PLACE HANDS OR FEET IN ANY CONVEYOR OPENING, TO AVOID BEING CAUGHT BETWEEN THE ROTATING CONVEYOR SCREW AND THE CONVEYOR HOUSING.**
3. **DO NOT WALK ON CONVEYOR COVERS OR GRATINGS OR POWER TRANSMISSION GUARDS, TO AVOID FALLING INTO OR AGAINST THE ROTATING CONVEYOR SCREW.**
4. **DO NOT** poke or prod material in the conveyor with a bar or stick, **to avoid being struck by the bar or stick.**
5. **DO NOT** overload conveyor or use it for anything but its intended use.
6. **DO** practice good housekeeping

A copy of Screw Conveyor Safety and Service Instructions are shipped as part of every order.



**THE EXPERIENCE
TO HANDLE IT RIGHT!**

Screw Conveyor Corporation®

EXPERIENCE IN MOTION



Screw
Conveyors

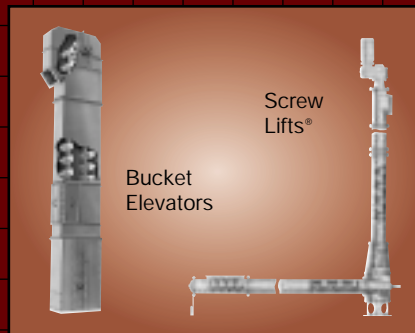

Screw
Lifts®
Bucket
Elevators

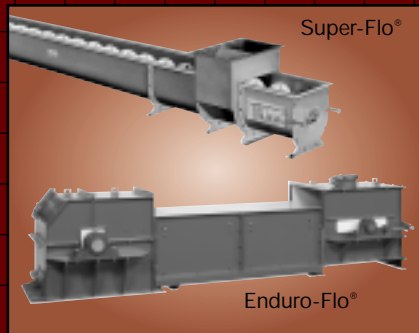

Super-Flo®

Enduro-Flo®

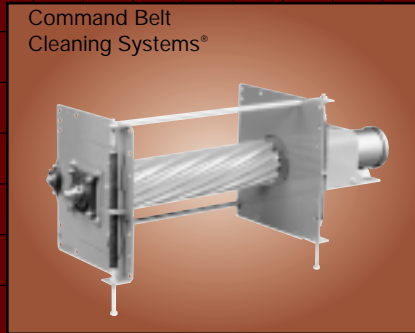

Command Belt
Cleaning Systems®

**For Over 70 Years We Have Been A Dependable Source For
Performance Proven Industrial Bulk Material Handling Equipment.
Put Our Experience to Work for You.**



**THE EXPERIENCE
TO HANDLE IT RIGHT!®**

Screw Conveyor Corporation®

700 HOFFMAN STREET, HAMMOND, INDIANA 46327-1894 PHONE 219-931-1450 FAX: 800-805-6527 WEB ADDRESS: www.screwconveyor.com
Winona, MS 662-283-3142 Visalia, CA 559-651-2131 Chanute, KS 620-431-0440 Guadalajara, Jal. Mexico 333-645-7110
FAX: 800-213-3084 FAX: 800-651-2135 FAX: 800-213-3086 FAX: 333-663-2369